

**Bay Linear Drain 2 in 1**

**Installation**



SKU	Size	Finish
38.100.05	24" x 2.75"	Satin
38.100.06	36" x 2.75"	Satin

**Set Includes:**

1. Lifting Key
2. Flat Stainless Steel or Tile-In Grate
3. Plastic Legs
4. Odor/Bugs Seal
5. QM 304 Stainless Steel Drain Base

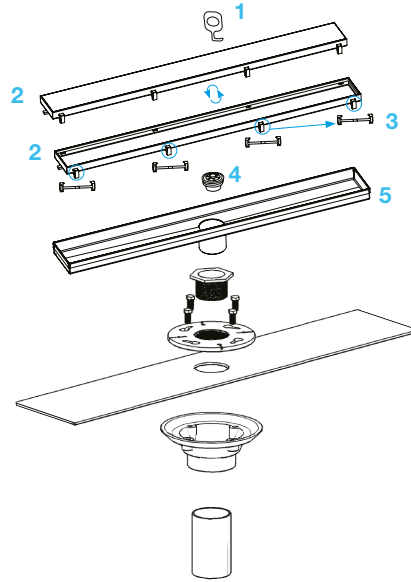
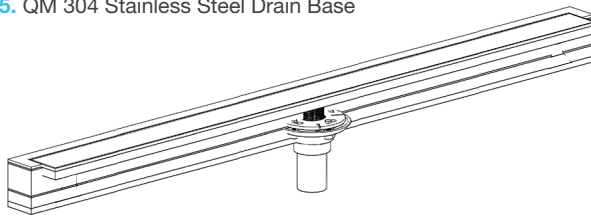

**Specifications**

**Grate Length Top View:**

Flat Stainless Steel or Tile-In Grate

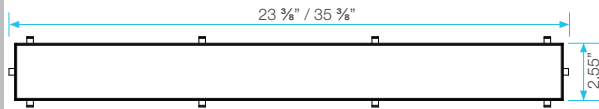

**Base Width and Height - Side View:**

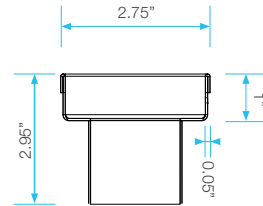

**Grate Width and Height - Side View:**

Flat Stainless Steel

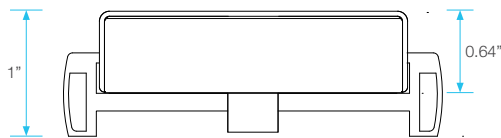

**Base Length Top View:**

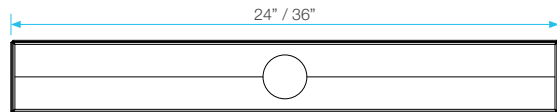

**Grate Width and Height - Side View:**

Tile-In Grate

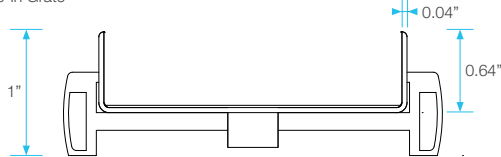

**Base Length - Side View:**

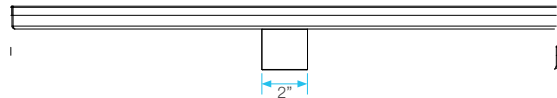

**Add to Kit**

**Drain Flange:**

- PVC SKU: 83.100.00 PVC
- ABS SKU: 83.100.00 ABS
- Cast Iron No hub: 83.100.01
- Cast Iron FIP: 83.100.01F

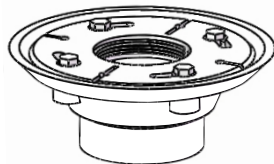

**Note:** Installer must verify all rough-in dimensions prior to installation and consult local and national codes. Conformity and compliance to local and national codes are the responsibility of the installer. Dimensions are subject to Manufacture tolerance and change without notice. We can assume no responsibility for use of superseded or void data.