

Bay Linear Drain 2 in 1

Installation



SKU	Size	Finish
38.100.05	24" x 2.75"	Satin
38.100.06	36" x 2.75"	Satin

Set Includes:

1. Lifting Key
2. Flat Stainless Steel or Tile-In Grate
3. Plastic Legs
4. Odor/Bugs Seal
5. QM 304 Stainless Steel Drain Base

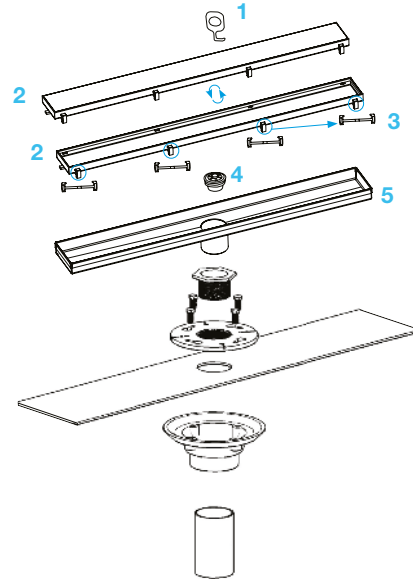
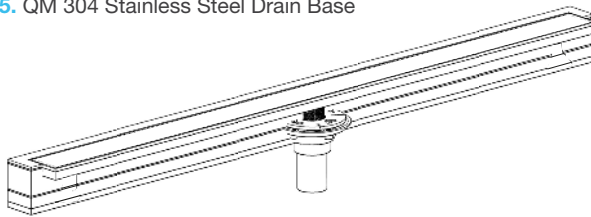

Specifications

Grate Length Top View:

Flat Stainless Steel or Tile-In Grate

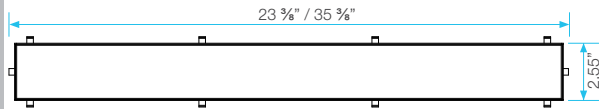

Base Width and Height - Side View:

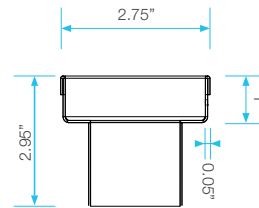

Grate Width and Height - Side View:

Flat Stainless Steel

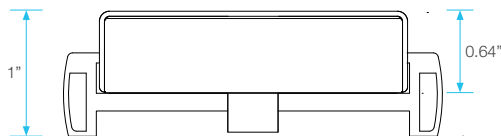

Base Length Top View:

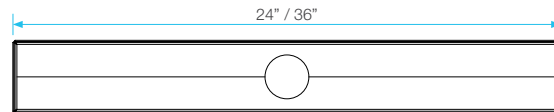

Grate Width and Height - Side View:

Tile-In Grate

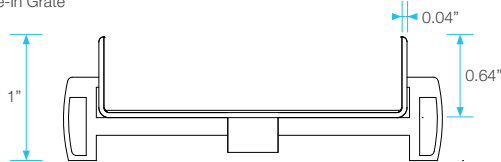

Base Length - Side View:

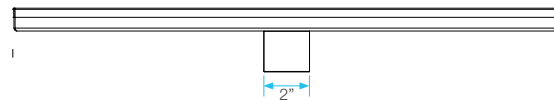

Add to Kit

Drain Flange:

- PVC SKU: 83.100.00 PVC
- ABS SKU: 83.100.00 ABS
- Cast Iron No hub: 83.100.01
- Cast Iron FIP: 83.100.01F



Note: Installer must verify all rough-in dimensions prior to installation and consult local and national codes. Conformity and compliance to local and national codes are the responsibility of the installer. Dimensions are subject to Manufacture tolerance and change without notice. We can assume no responsibility for use of superseded or void data.