

## BAY LINEAR DRAIN 2 IN 1

### Kit Includes:

- A** Lifting Key
- B** Flat Stainless Steel or Tile-In Grate
- C** Plastic Legs
- D** Odor/Bugs Seal
- E** QM 304 Stainless Steel Drain Base

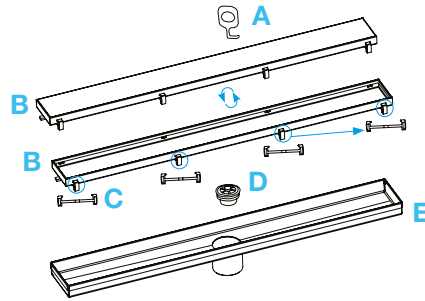

### Specifications

**B Grate - Top View**

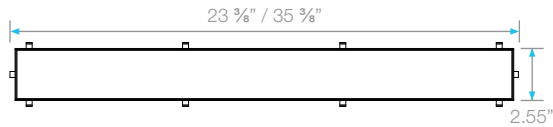

**Side View**

Flat Stainless Steel

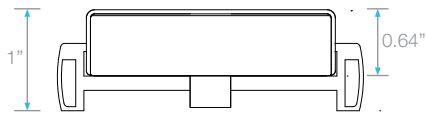

Tile-in Grate

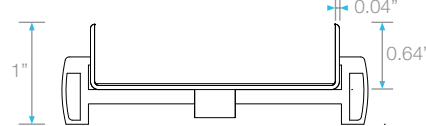

**E Base - Side View**

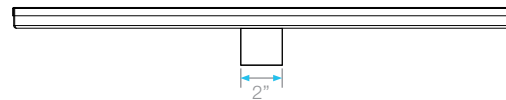
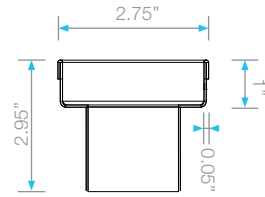

**Top View**

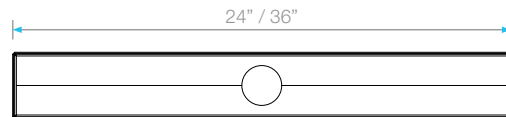

### Complete Kit



Length	Satin SKU
24"	38.100.05
36"	38.100.06

### Add to Kit



Drain Flange	SKU
2" PVC	83.100.00 PVC
2" ABS	83.100.00 ABS
2" Cast Iron No hub	83.100.01
2" Cast Iron FIP	83.100.01F

**Note:** Installer must verify all rough-in dimensions prior to installation and consult local and national codes. Conformity and compliance to local and national codes are the responsibility of the installer. Dimensions are subject to Manufacturers tolerance and change without notice. We can assume no responsibility for use of superseded or void data.