

**DELMAR LINEAR DRAIN STANDARD LENGTH WITH FLANGE EDGE**

**Kit Includes:**

- A** Lifting Key
- B** Grate
- C** Hair/Debris Strainer
- D** Trims
- E** Flange Edge Base
- F** Leveling Legs

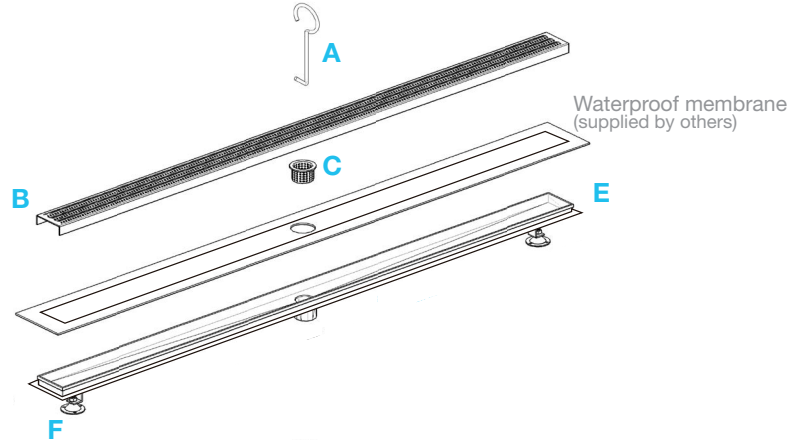

**Specifications**

**B Grate - Top View**

Nami - Kai

24" / 28" / 32" / 36"

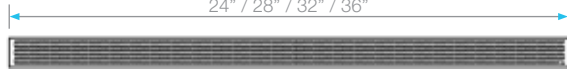

Mist

24" / 28" / 32" / 36" / 48" / 58"



Delta - Wedgewire

24" / 28" / 32" / 36" / 48" / 58"



**Side View**

Nami - Kai - Delta

3.15"



Mist

3.15"

2.80"

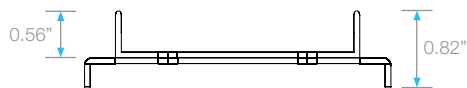

**E Base - Side View**

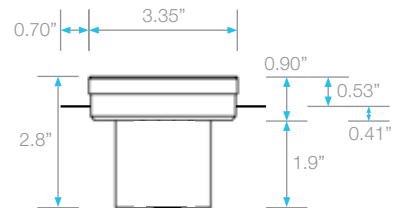

**Top View**

Nami - Kai

24" / 28" / 32" / 36"

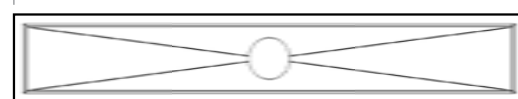

Delta - Mist - Wedgewire

24" / 28" / 32" / 36" / 48" / 58"

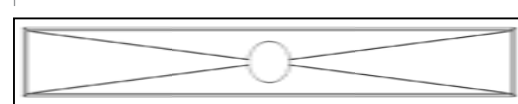

**Side View**

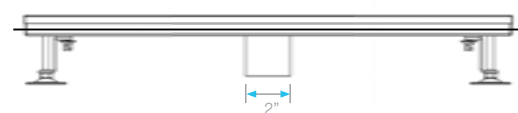

### Delmar Series Features

- 16 gauge 316 Stainless Steel Grate = 1.5 mm.
- 18 gauge 316 Stainless Steel Base = 1.2 mm.
- Works with 2" ABS, PVC or Cast Iron shower drain flange (not included).
- Grate can be removed completely for cleaning.
- Hair Strainer Basket comes with every drain, fits inside the drain to collect hair and other debris, preventing pipe clogs.
- Standard Finishes: Satin and Polished.
- Delmar Series is intended for use with traditional waterproofing methods.

### Complete Kit

	Length	Satin SKU	Polished SKU		Length	Satin SKU
 <p><b>Wedgwire</b></p>	24"	33.700.02 F	33.700.02 P F	 <p><b>Mist (Tile-in)</b></p>	24"	33.500.02 F
	28"	33.700.03 F	33.700.03 P F		28"	33.500.03 F
	32"	33.700.04 F	33.700.04 P F		32"	33.500.04 F
	36"	33.700.05 F	33.700.05 P F		36"	33.500.05 F
	48"	33.700.06 F	33.700.06 P F		48"	33.500.06 F
	58"	33.700.07 F	33.700.07 P F		58"	33.500.07 F
 <p><b>Delta</b></p>	24"	33.300.02 F	33.300.02 P F	 <p><b>Kai</b></p>	24"	33.200.02 F
	28"	33.300.03 F	33.300.03 P F		28"	33.200.03 F
	32"	33.300.04 F	33.300.04 P F		32"	33.200.04 F
	36"	33.300.05 F	33.300.05 P F		36"	33.700.05 F
	48"	33.300.06 F	33.300.06 P F	 <p><b>Nami</b></p>	24"	33.100.02 F
	58"	33.300.07 F	33.300.07 P F		28"	33.100.03 F
					32"	33.100.04 F
					36"	33.100.05 F

#### Kit includes

- Lifting Key
- Grate
- Hair/Debris Strainer
- Base
- Leveling Legs
- Threaded Nipple/Adapter

### Add to Kit

	Drain Flange	SKU
	2" PVC	83.100.00 PVC
	2" ABS	83.100.00 ABS
	2" Cast Iron No hub	83.100.01
	2" Cast Iron FIP	83.100.01F

**Note:** Installer must verify all rough-in dimensions prior to installation and consult local and national codes. Conformity and compliance to local and national codes are the responsibility of the installer. Dimensions are subject to Manufacturers tolerance and change without notice. We can assume no responsibility for use of superseded or void data.