

DELMAR LINEAR DRAIN STANDARD LENGTH WITH SIDE OUTLET FLANGE EDGE

- Kit Includes:**
- A** Lifting Key
 - B** Grate
 - C** Flange Edge Base
 - D** Leveling Legs

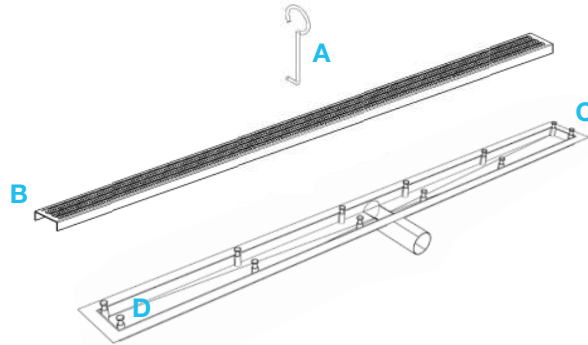

Specifications

B Grate - Top View
Nami - Kai

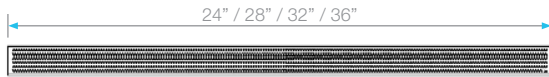

Mist



Delta - Wedgewire - Lotus

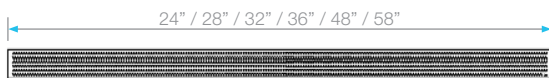

Side View

Nami - Kai - Delta - Lotus - Wedgewire

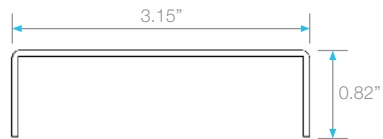

Mist (Tile-in)

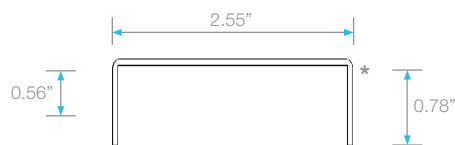

*Note: Tile-In grate accepts flooring material up to 1" thickness

C Base - Side View

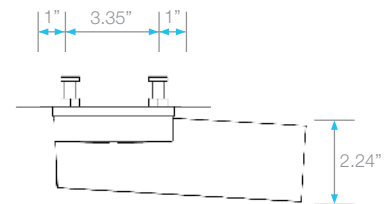

Top View
Nami - Kai

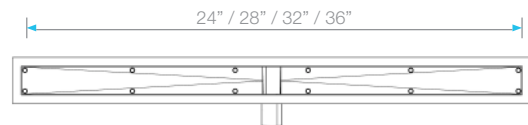

Delta - Mist - Wedgewire - Lotus

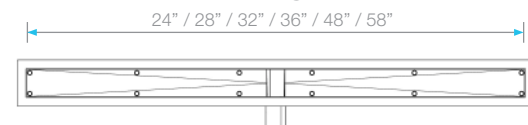







Side View



Features

- Stainless Steel 316 Gauges:
 Wedgewire grate: 8 gauges = 5mm for edge bars and 9 gauges= 4mm for inside bars.
 All other grates: 16 gauge = 1.5 mm.
 Base: 18 gauge = 1.2 mm
- Grate can be removed completely for cleaning.
- Side Outlet Flange Edge Base is intended for use with modern waterproofing method

Complete Kit

 Wedgewire	Length	Satin SKU	Polished SKU	Black SKU	
	24"	33.700.24FSO ST	33.700.24FSO PS	33.700.24F BK	
	28"	33.700.28FSO ST	33.700.28FSO PS	33.700.28F BK	
	32"	33.700.32FSO ST	33.700.32FSO PS	33.700.32F BK	
	36"	33.700.36FSO ST	33.700.36FSO PS	33.700.36F BK	
	48"	33.700.48FSO ST	33.700.48FSO PS	33.700.48F BK	
 Kai	Length	Satin SKU			
	24"	33.200.02FSO ST			
	28"	33.200.03FSO ST			
	32"	33.200.04FSO ST			
	36"	33.700.05FSO ST			
 Mist (Tile-in)	Length	Satin SKU			
	24"	33.500.24FSO ST			
	28"	33.500.28FSO ST			
	32"	33.500.32FSO ST			
	36"	33.500.36FSO ST			
	48"	33.500.48FSO ST			
 Delta	Length	Satin SKU	Polished SKU		
	24"	33.300.24FSO ST	33.300.24FSO PS		
	28"	33.300.28FSO ST	33.300.28FSO PS		
	32"	33.300.32FSO ST	33.300.32FSO PS		
	36"	33.300.36FSO ST	33.300.36FSO PS		
	48"	33.300.48FSO ST	33.300.48FSO PS		
 Nami	Length	Satin SKU			
	24"	33.100.24FSO ST			
	28"	33.100.28FSO ST			
	32"	33.100.32FSO ST			
	36"	33.100.36FSO ST			
 Lotus	Length	Bronze SKU	Black SKU	Gold SKU	
	24"	33.400.28FSO BZ	33.400.24FSO BK	33.400.24F GD	
	28"	33.400.28FSO BZ	33.400.28FSO BK	33.400.28F GD	
	32"	33.400.32FSO BZ	33.400.32FSO BK	33.400.32F GD	
	36"	33.400.36FSO BZ	33.400.36FSO BK	33.400.36F GD	
	48"	33.400.48FSO BZ	33.400.48FSO BK	33.400.48F GD	
58"	33.400.58FSO BZ	33.400.58FSO BK	33.400.58F GD		

Note: Installer must verify all rough-in dimensions prior to installation and consult local and national codes. Conformity and compliance to local and national codes are the responsibility of the installer. Dimensions are subject to Manufacturers tolerance and change without notice. We can assume no responsibility for use of superseded or voided data.