

DELMAR LINEAR DRAIN STANDARD LENGTH

Kit Includes:

- A** Lifting Key
- B** Grate
- C** Hair/Debris Strainer
- D** Base
- E** Leveling Legs
- F** Threaded nipple

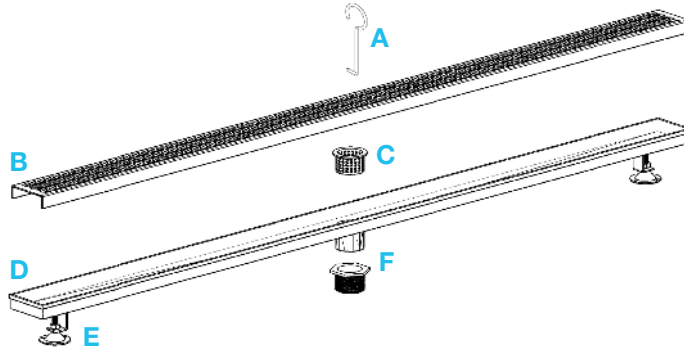

Specifications

B Grate - Top View

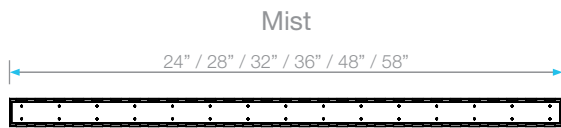

D Base - Side View

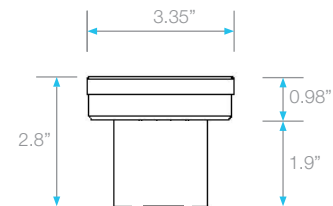

Top View

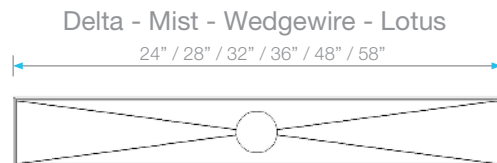
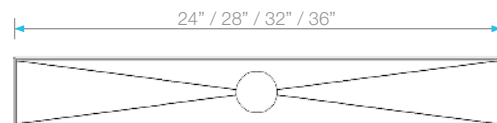

Side View

Nami - Kai - Delta - Lotus - Wedgewire



Mist (Tile-in)

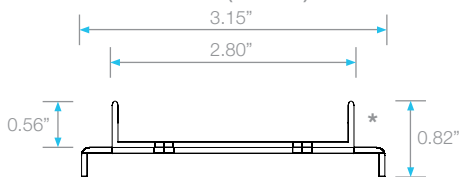

*Note: Tile-In grate accepts flooring material up to 1/2" tickness

Side View

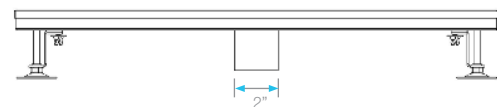

Features

- Stainless Steel 316 Gauges:
 - Wedgewire grate: 8 gauges = 5mm for edge bars and 9 gauges= 4mm for inside bars.
 - All other grates: 16 gauge = 1.5 mm.
- Base: 18 gauge = 1.2 mm
- Works with 2" ABS, PVC or Cast Iron shower drain flange (not included).
- Standard length plain edge is intended for use with traditional waterproofing methods.
- Grate can be removed completely for cleaning.
- Hair Strainer Basket comes with every drain, fits inside the drain to collect hair and other debris, preventing clogged pipes.

Complete Kit

 Lotus	Length	Bronze		Black		Satin Gold		
			SKU	SKU	SKU	SKU	SKU	SKU
		24"	33.400.24 BZ	33.400.24 BK	33.400.24 GD			
		28"	33.400.28 BZ	33.400.28 BK	33.400.28 GD			
		32"	33.400.32 BZ	33.400.32 BK	33.400.32 GD			
		36"	33.400.36 BZ	33.400.36 BK	33.400.36 GD			
 Wedgewire	Length	Satin		Polished		Black		
			SKU	SKU	SKU	SKU	SKU	SKU
		24"	33.700.24 ST	33.700.24 PS	33.400.24 BK			
		28"	33.700.28 ST	33.700.28 PS	33.400.28 BK			
		32"	33.700.32 ST	33.700.32 PS	33.400.32 BK			
		36"	33.700.36 ST	33.700.36 PS	33.400.36 BK			
 Delta	Length	Satin		Polished				
			SKU	SKU	SKU	SKU	SKU	SKU
		24"	33.300.24 ST	33.300.24 PS				
		28"	33.300.28 ST	33.300.28 PS				
		32"	33.300.32 ST	33.300.32 PS				
		36"	33.300.36 ST	33.300.36 PS				
 Nami	Length	Satin						
			SKU	SKU	SKU	SKU	SKU	SKU
		24"	33.100.24 ST					
		28"	33.100.28 ST					
		32"	33.100.32 ST					
		36"	33.100.36 ST					
 Mist (Tile-in)	Length	Satin		Black				
			SKU	SKU	SKU	SKU	SKU	SKU
		24"	33.500.24 ST	33.500.24 BK				
		28"	33.500.28 ST	33.500.28 BK				
		32"	33.500.32 ST	33.500.32 BK				
		36"	33.500.36 ST	33.500.36 BK				
 Kai	Length	Satin						
			SKU	SKU	SKU	SKU	SKU	SKU
		24"	33.200.24 ST					
		28"	33.200.28 ST					
		32"	33.200.32 ST					
		36"	33.200.36 ST					

Add to Kit (Specification Pages: XX-XX)

	Drain Flange	SKU		Square Drain Flange	SKU
	2" PVC	83.FLG.2.PVC		2" PVC	83.SQFLG.2.PVC
	2" ABS	83.FLG.2.ABS		2" ABS	83.SQFLG.2.ABS
	2" Cast Iron No hub	83.FLG.2.CI		2" Cast Iron No hub	83.SQFLG.2.CI
	2" Cast Iron FIP	83.FLG.2.CI.IP		2" Cast Iron FIP	83.SQFLG.2.CI.IP

Note: Installer must verify all rough-in dimensions prior to installation and consult local and national codes. Conformity and compliance to local and national codes are the responsibility of the installer. Dimensions are subject to Manufacturers tolerance and change without notice. We can assume no responsibility for use of superseded or voided data.