

## DELMAR LINEAR DRAIN SUPREME LINE

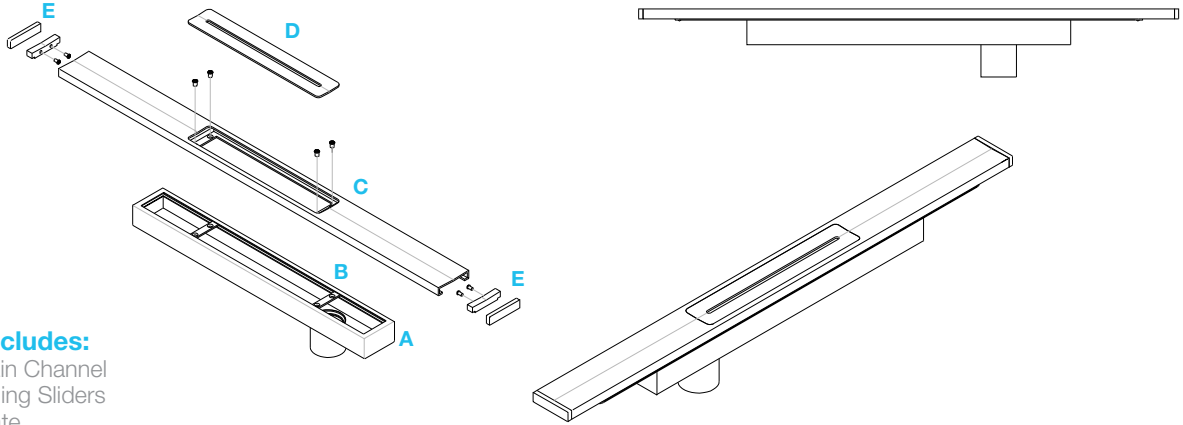

**Kit includes:**

- A** Drain Channel
- B** Railing Sliders
- C** Grate
- D** Removable Grate
- E** Grate End-Cap

+ Screws, Sealant, Hair Strainer, Key, Level, Wedges, Stainless Steel Blade

### Specifications

**C Grate - Top View**

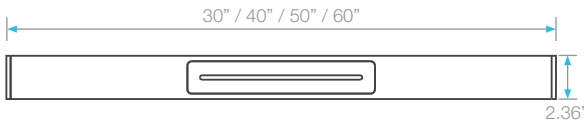

**Side View**

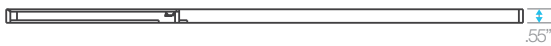

**A Channel - Top View**

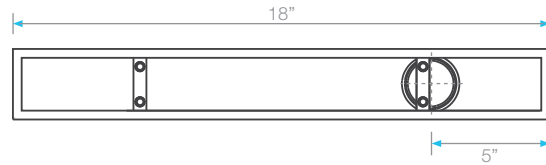

**Side View**

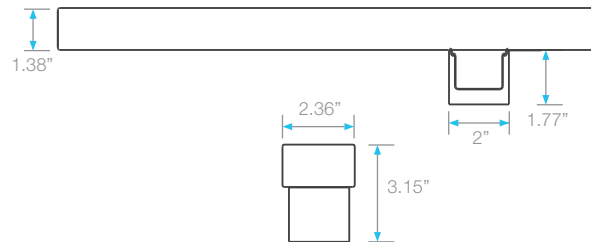

**D Removable Grate - Top View**



**Side View**

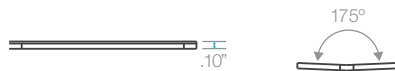



  
 USA - ASME A 112.18.2-2011/  
 CAN - CSA B 125.2-11.  
 Certificate #2689051

**QM USA, Corp.**  
 4100 N Powerline Road, Suite Z3  
 Pompano Beach, FL, USA 33073  
 P: 954 773 9450 • info@qm-us.com  
[www.qmdrain.com](http://www.qmdrain.com)

### Features

- 13 gauge 316 Stainless Steel Grate = 2.5 mm.
- 18 gauge 316 Stainless Steel Base = 1.2 mm.
- Works with 2" ABS, PVC or Cast Iron shower drain flange (not included).
- Hair Strainer Basket comes with every drain, fits inside the drain to collect hair and other debris, preventing clogged pipes. Optional.
- Supreme is intended for use with traditional waterproofing methods.

### Supreme Complete Kit



Satin	
SKU	Length
33.800.30 ST	30"
33.800.40 ST	40"
33.800.50 ST	50"
33.800.60 ST	60"



Satin Gold	
SKU	Length
33.800.30 GD	30"
33.800.40 GD	40"
33.800.50 GD	50"
33.800.60 GD	60"



Polished	
SKU	Length
33.800.30 PS	30"
33.800.40 PS	40"
33.800.50 PS	50"
33.800.60 PS	60"



Black	
SKU	Length
33.800.30 BK	30"
33.800.40 BK	40"
33.800.50 BK	50"
33.800.60 BK	60"

### Add to Kit (Specification Pages: XX-XX)



Drain Flange	SKU
2" PVC	83.FLG.2.PVC
2" ABS	83.FLG.2.ABS
2" Cast Iron No hub	83.FLG.2.CI
2" Cast Iron FIP	83.FLG.2.CI.IP



Square Drain Flange	SKU
2" PVC	83.SQFLG.2.PVC
2" ABS	83.SQFLG.2.ABS
2" Cast Iron No hub	83.SQFLG.2.CI
2" Cast Iron FIP	83.SQFLG.2.CI.IP

**Note:** Installer must verify all rough-in dimensions prior to installation and consult local and national codes. Conformity and compliance to local and national codes are the responsibility of the installer. Dimensions are subject to Manufacturers tolerance and change without notice. We can assume no responsibility for use of superseded or void data.